



INSTALLATION INSTRUCTIONS

Accessory

FRONT SPLASH GUARDS
P/N 08P08-S9A-100A

Application

2005 CR-V

Publications No.

All 27178

Issue Date

SEP 2004

PARTS LIST

Left front splash guard

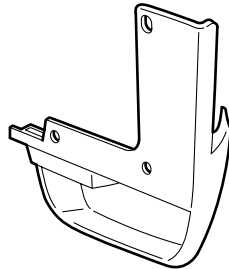

Right front splash guard

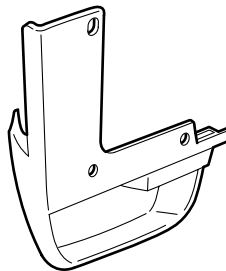

TOOL REQUIRED

Stubby Phillips screwdriver

INSTALLATION

NOTE: These instructions show the left splash guard being installed. The same procedure applies to installing the right splash guard.

1. Make sure the area to be covered is clean.
2. Turn the steering wheel all the way counterclockwise.
3. Remove and retain the three self-tapping screws that fasten the left front inner fender to the front fender and fenderwell.

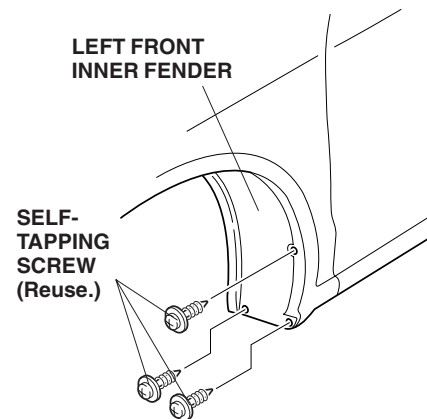

4. Position the splash guard on the left front inner fender. Install three self-tapping screws you removed. Tighten the three self-tapping screws in the order shown.

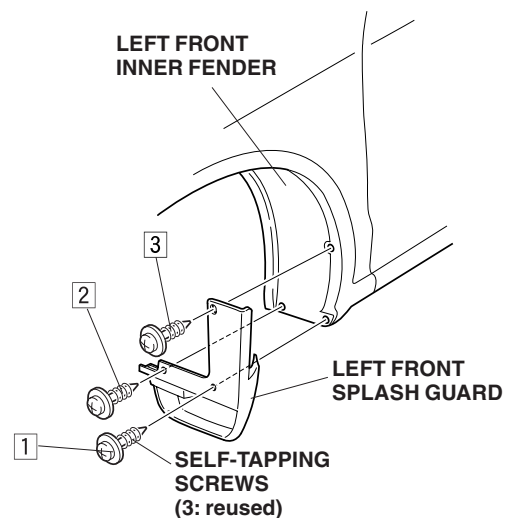

5. Turn the steering wheel all the way clockwise and repeat steps 3 and 4 to install the right front splash guard.